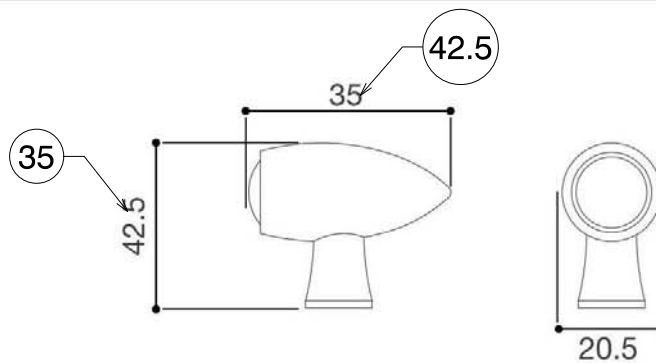

E4

E4-50R-00.2328

Issued by:	RDW – Vehicle Technology Division Zoetermeer Europaweg 205 PO Box 777 2700 AT Zoetermeer
Place & Date of type-approval:	Zoetermeer, 14.02.2014
Report No.:	2166393-PHO 13-276-08
Issued by:	DEKRA Certification B.V. - Photometry Utrechtseweg 310, 6218 AR Arnhem P.O. Box 5185, 6802 ED Arnhem The Netherland
Date of issue:	07.02.2014
Approval identification:	E4-50R-00.2328

Product Codes: FR155B, FR155CH.**Technical Drawing:**

Marking:	Printed in low relief by stamping.
Field of application:	2 or 3 wheel motorcycles and vehicles treated as such. (PTWs, ATVs, Scooters, Motorcycles, Moped)

